

Axis Position Indicator Instructions

The API System is valuable for:

1. Tracking change in position of condyles during occlusal splint treatment
2. Proving stability (repeatable position) of condyles over a period of time
3. Proving accuracy of centric relation records
4. Determining MIP/CR discrepancies.

- 1) API/CPI graph papers
- 2) Horizontal graph support
- 3) Left side vertical graph support
- 4) Right side vertical graph support

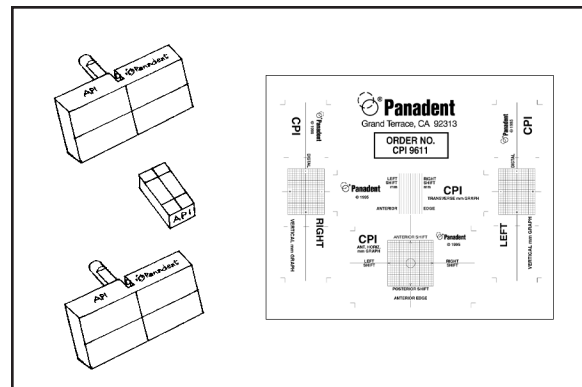

1

Raise and lock incisal pin and support post (arrow) at least 5mm above incisal table in preparation for using API system.

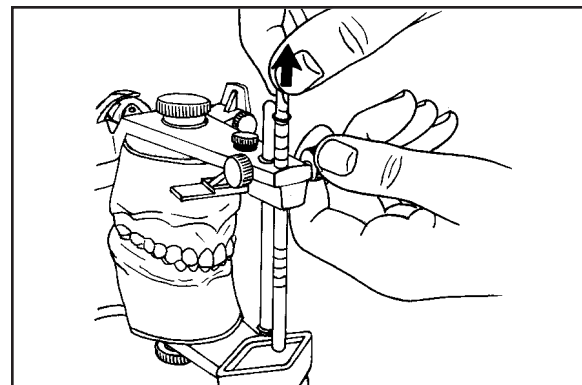

2

Release centric latch (arrow). Be sure centric pin springs upward to disengage centric channel of mandibular frame.

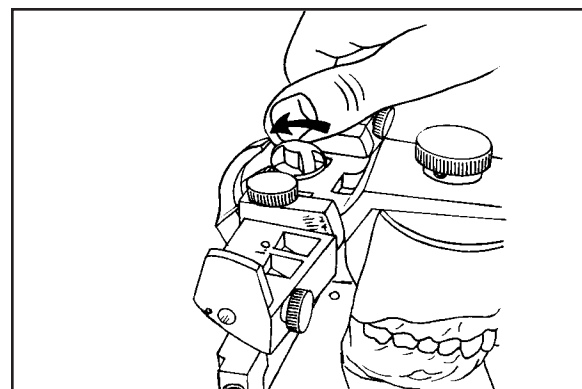

3

4

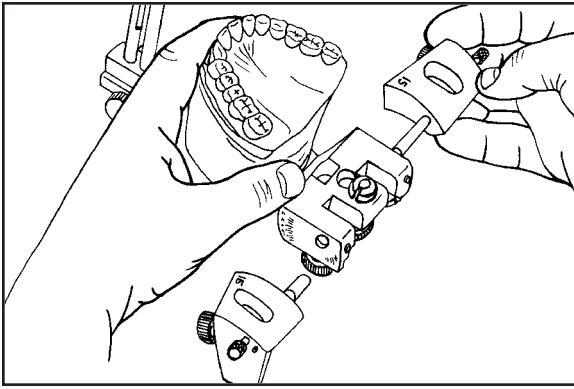

Separate articulator frames, loosen lock and thumb screws and remove analogs.

5

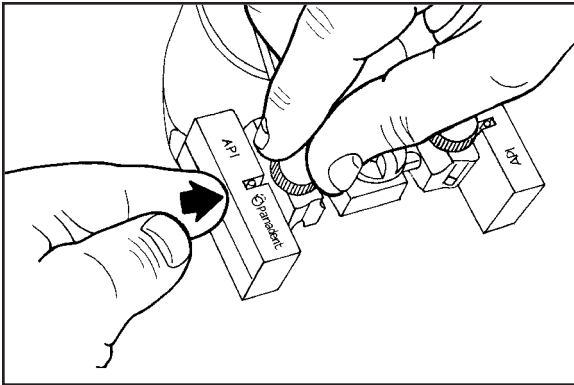

Insert right and left vertical graph supports into axis holes completely (arrow) and tighten retaining thumb screws on articulator frame.

6

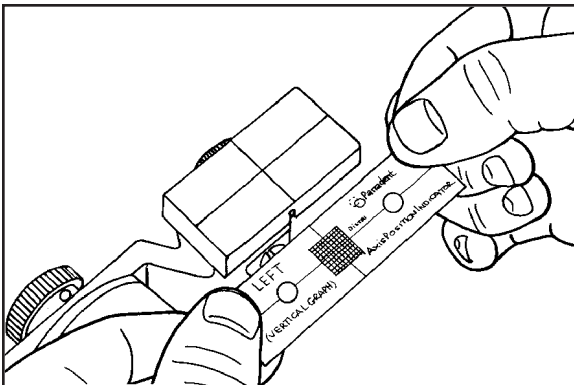

In preparation for placing right and left vertical graph papers, place upper frame of articulator on side. Remove crack and peel backing from graph paper.

7

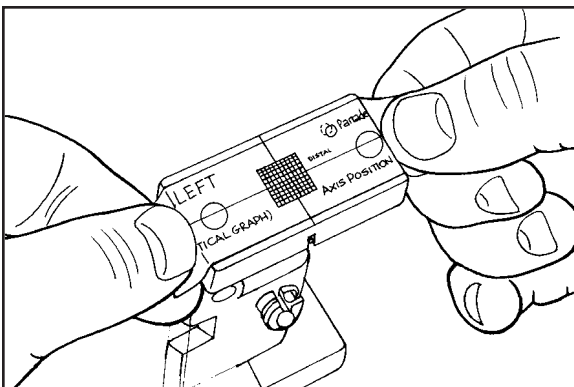

Orient vertical and horizontal lines on graph papers coincident with corresponding lines on support blocks, then press firmly to place on graph supports. Fold ends back.

Place elastic band over centric latch to hold latch in downward position.

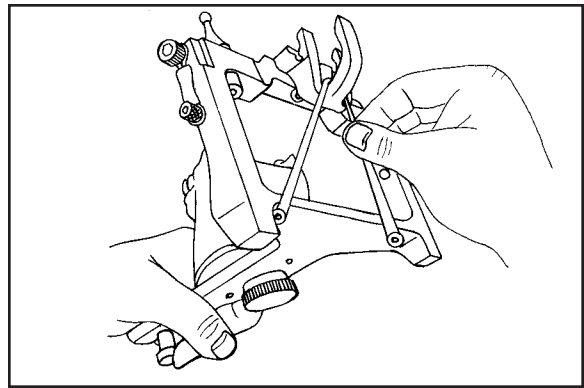

8

Loosen screw with hex wrench and remove centric channel.

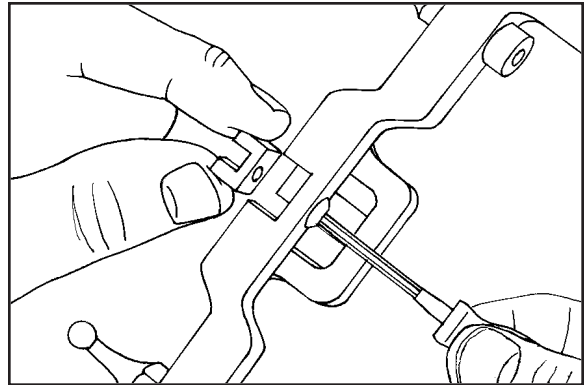

9

Remove crack and peel backing from horizontal graph paper. Match midline of paper with midline on support. Press paper to adhere to support.

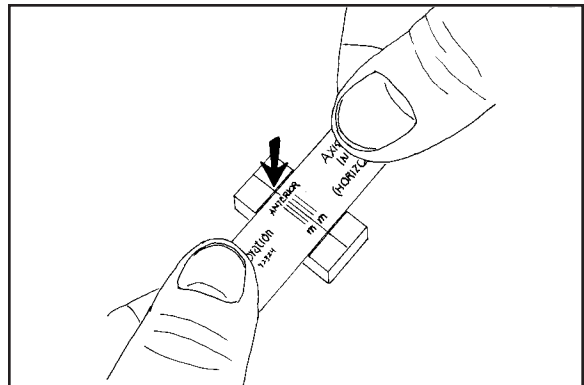

10

Use extending ends of graph paper to place graph support in centric channel slot.

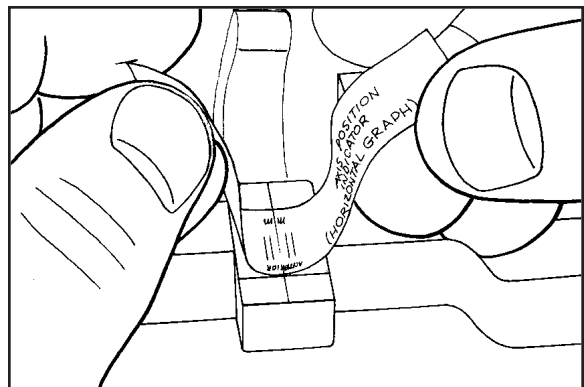

11

12

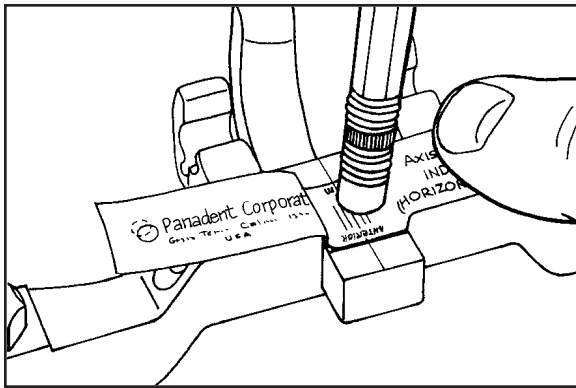

Push graph paper support completely down. With aid of pencil eraser, pad graph paper to place. Fold paper ends onto centric truss bar.

13

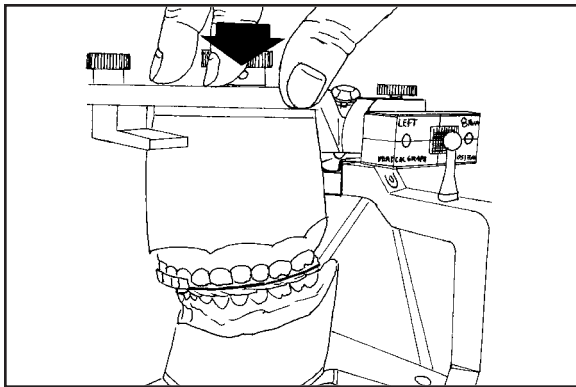

Place new centric record between casts. Press firmly down on upper frame of articulator to keep casts seated properly in centric record (arrow).

14

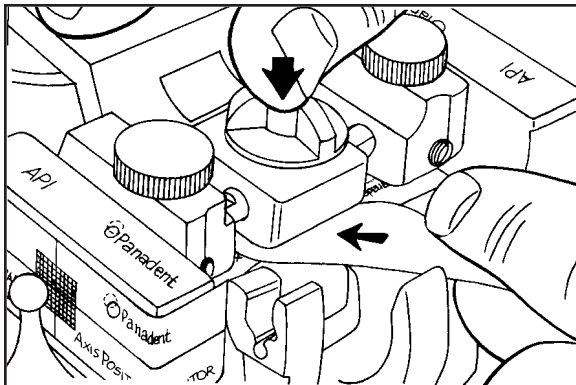

Place mylar marking strip (horizontal arrow) ink side down, between lower end of centric locator pin and graph paper. Depress centric pin cap (vertical arrow) to transfer dye from end of pin to graph paper.

15

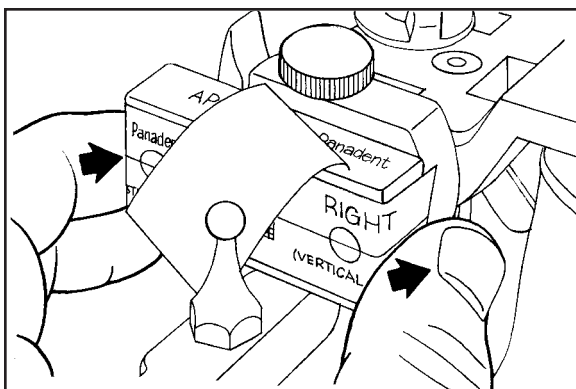

Continue to press firmly downward above casts. Place strip of mylar marking ribbon (dye side toward graph paper) between vertical graph papers and condylar elements. Push inward on graph supports (arrows).

While pressing firmly downward on casts with one hand, pull laterally on graph support (arrows) to strike condyle element and cause dye on ribbon to be transferred to graph paper.

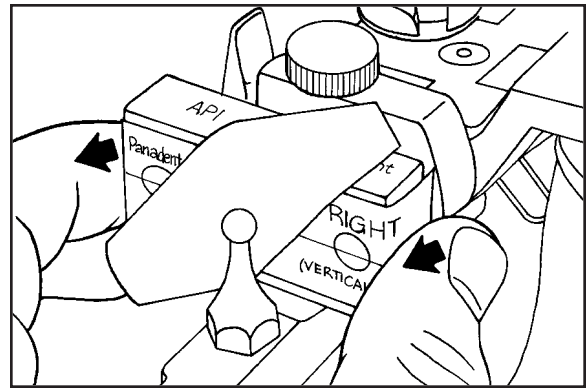

16

Various colored marking ribbons may be used to distinguish original axis spot from subsequent ones. Spot at intersection of lines represents mounting of casts with first centric record.

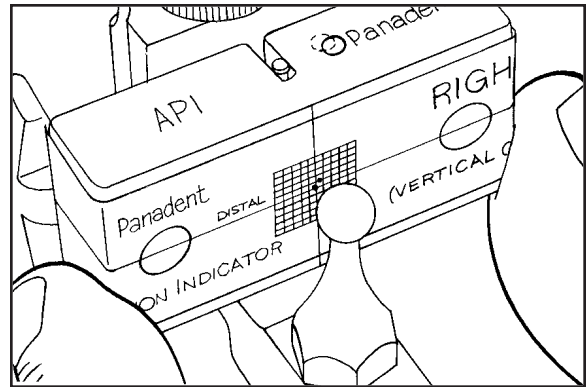

17

Figure shows original mounting position (mark at intersection) and later centric relation record. The axis has moved upward about 1.2mm and forward about .75mm.

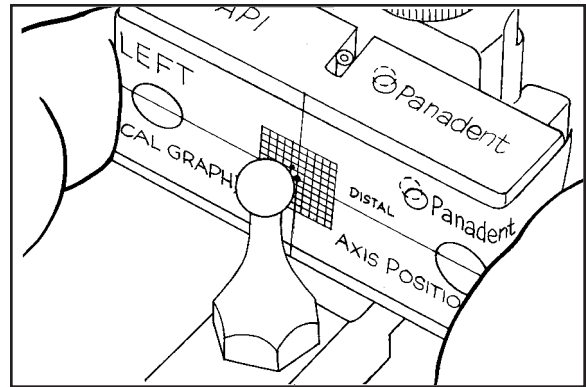

18

Arrow shows original position of mounted casts (spot on center line) and second position lateral to it for second centric record. Axis has shifted left about .5 mm.

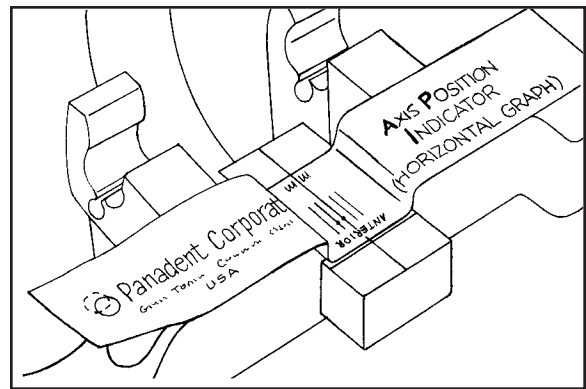

19

20

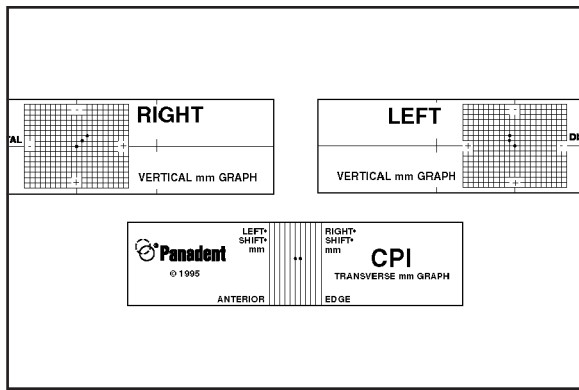

Remove and store graph papers on thin sheet of plastic. Place sheet with graphs in clear plastic envelope for storage. Graph papers can be remove and replaced on graph supports for future axis position determinations.

21

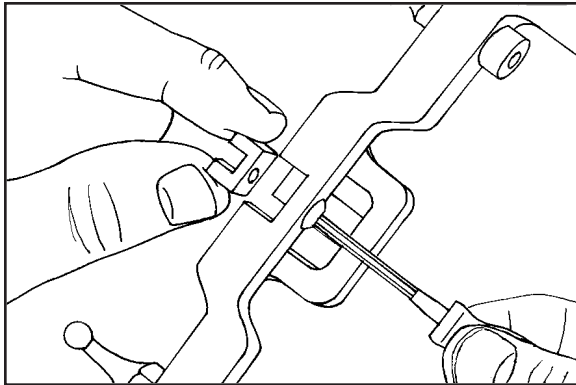

Replace centric channel.

22

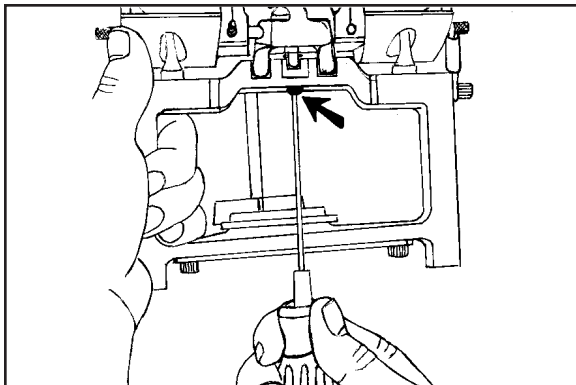

Replace motion alalogs and reconnect frames of articulator. Tighten screw (arrow) to adjust freedom of centric pin in channel.